

CATALOGUE 2022, BVT Technologies, a.s.



Contact us for more information
E-mail: info@bvt.cz, Tel.: +420 775 605 538
www.bvt.cz, Follow us on Facebook

BVT PRODUCTS

- SENSORS
 - screen printed electrodes
- ELECTRODES
- STIRRERS
- CABLES AND CONNECTORS
- MANUAL SCREEN PRINTER
- CELLS
- POTENTIOSTATS
- MINITHERMOSTAT
- PUMPS
- ACCESSORIES

STANDARD SPECIFICATION OF SENSORS

XY*1.W*2.R*3.*4

X - A = Amperometry,
C = Conductometry,
B = Coulometry....

Y - C = Ceramics, P = Plastic, G = Glass

*1 - number of topology

*2 - number material of working electrode (electrodes)
S - Au+Pt alloy - with high adhesion to sensor substrate

1 - pure Au

2 - pure Pt - lower adhesion to sensor substrate

3 - Ag

4 - Graphite (in polymeric binder)

- the resistance of surface and output contact lies in range (0,1-10 k Ω), low price

5 - Manually microdispensed Graphite (in polymeric binder) and Au+Pt alloy AUX

- the resistance of surface and output contact lies in range (1-10 Ω)

*3 - material of reference electrode

S - Ag

1 - Ag and AgCl in polymeric binder - low stability

2 - Ag electrolytically covered by AgCl

*4 - Additional specification of accessories or special properties
(heating, thermistor, Pt1000 thermometer, working electrode area,..)

Comment: the specification is transferred to classical electrodes if it is appropriate

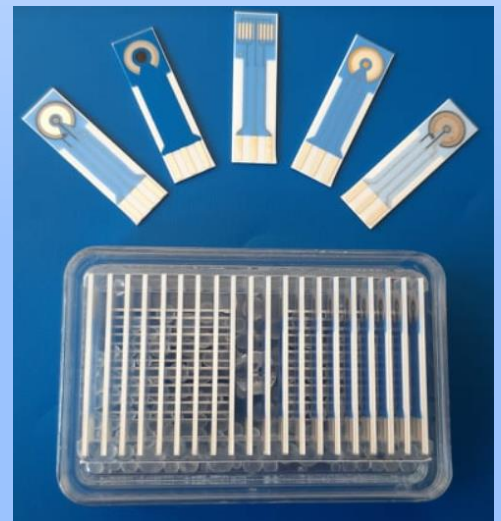

DIAMETER of WE

The sensors are formed on a corundum ceramic base. On to this surface the working, the reference and the auxiliary electrodes are applied. The working and the auxiliary electrodes are made of variety of materials (WS=Au/Pt, W1=Au, W2=Pt, W3 = Ag, W4=graphite, W5= manually microdispensed graphite and Au+Pt alloy AUX).

The materials as Zn, Al, Cu, Mg, ...can be used for working electrode on special demand.

SENSOR AC1.W*.R*, Diameter of WE is 1 mm

Basic amperometric low cost three-electrode sensor.

Dimensions: 25.4 x 7.26 x 0.63 mm

SENSOR AC1.W*.R*, Diameter of WE is 2 mm

Basic amperometric low cost three-electrode sensor with patented structure .

Dimensions: 25.4 x 7.26 x 0.63 mm

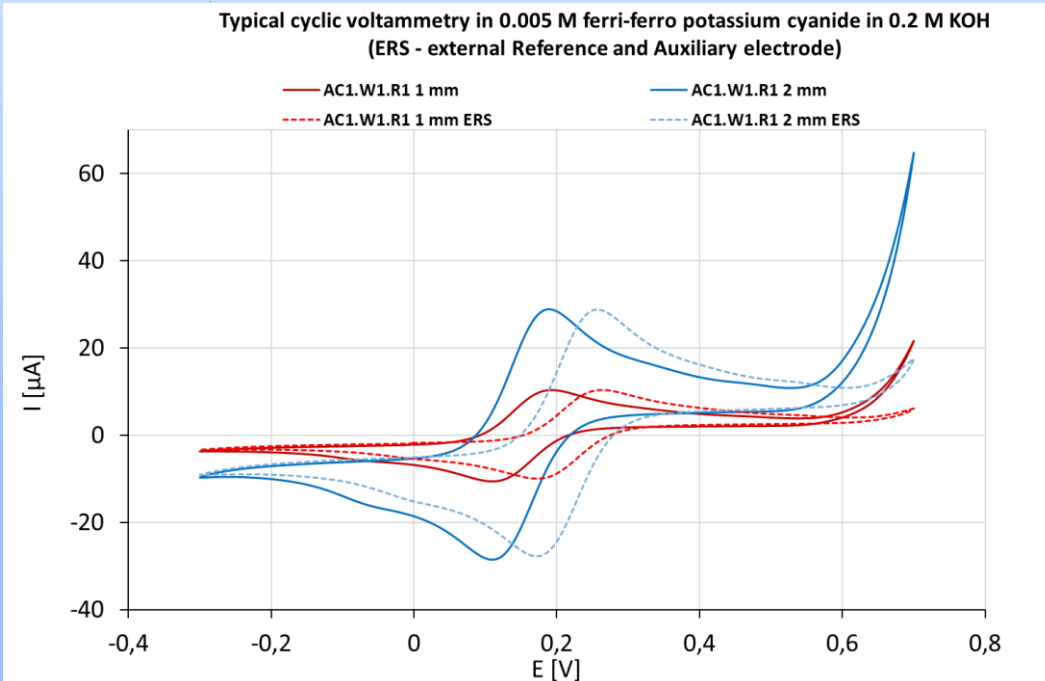

SENSOR AC1.W*.R*, Diameter of WE area is 3 mm (6,8 mm²)

Basic amperometric low cost three-electrode sensor with patented structure .

Dimensions: 25.4 x 7.26 x 0.63 mm

SENSOR AC1.W*.R*, Diameter of WE area is 4 mm (12,7 mm²)

Basic amperometric low cost three-electrode sensor with patented structure .

Dimensions: 25.4 x 7.26 x 0.63 mm

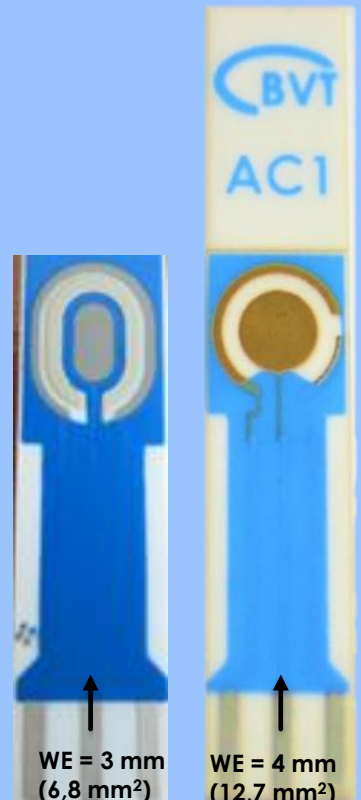
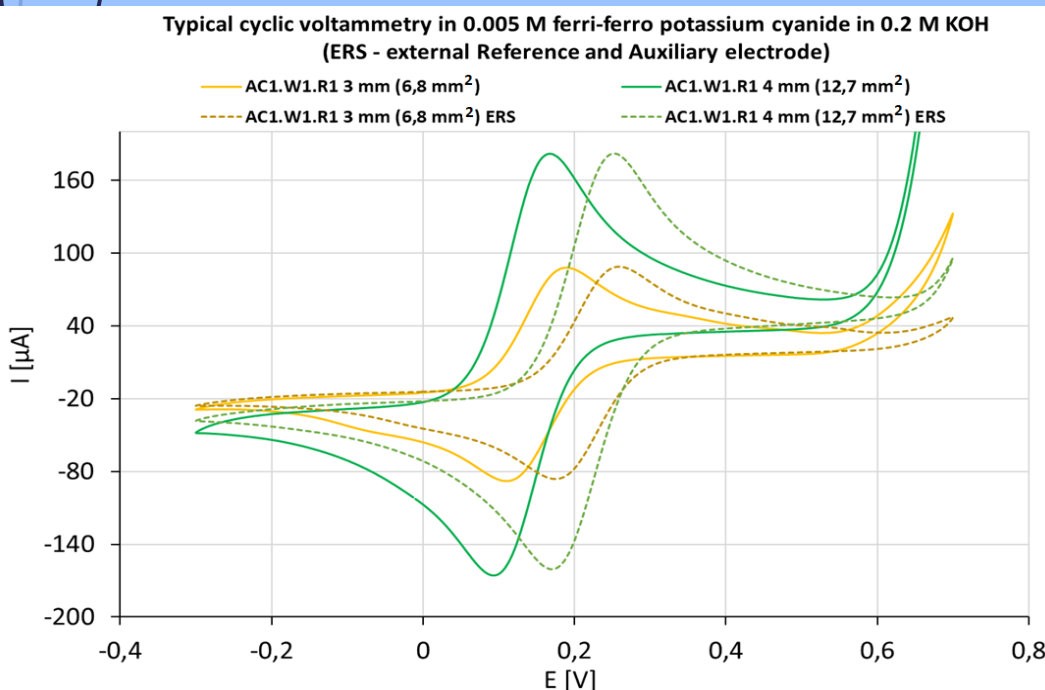

DIAMETER of WE

The active surface of sensors lies in range +/- 10 %.

Bigger active surface has better geometrical accuracy. The sensors quality is controlled statistically. It is possible to deliver sensors with lower parameters variability.

Image of AC1.W1.RS sensor electrodes under a microscope

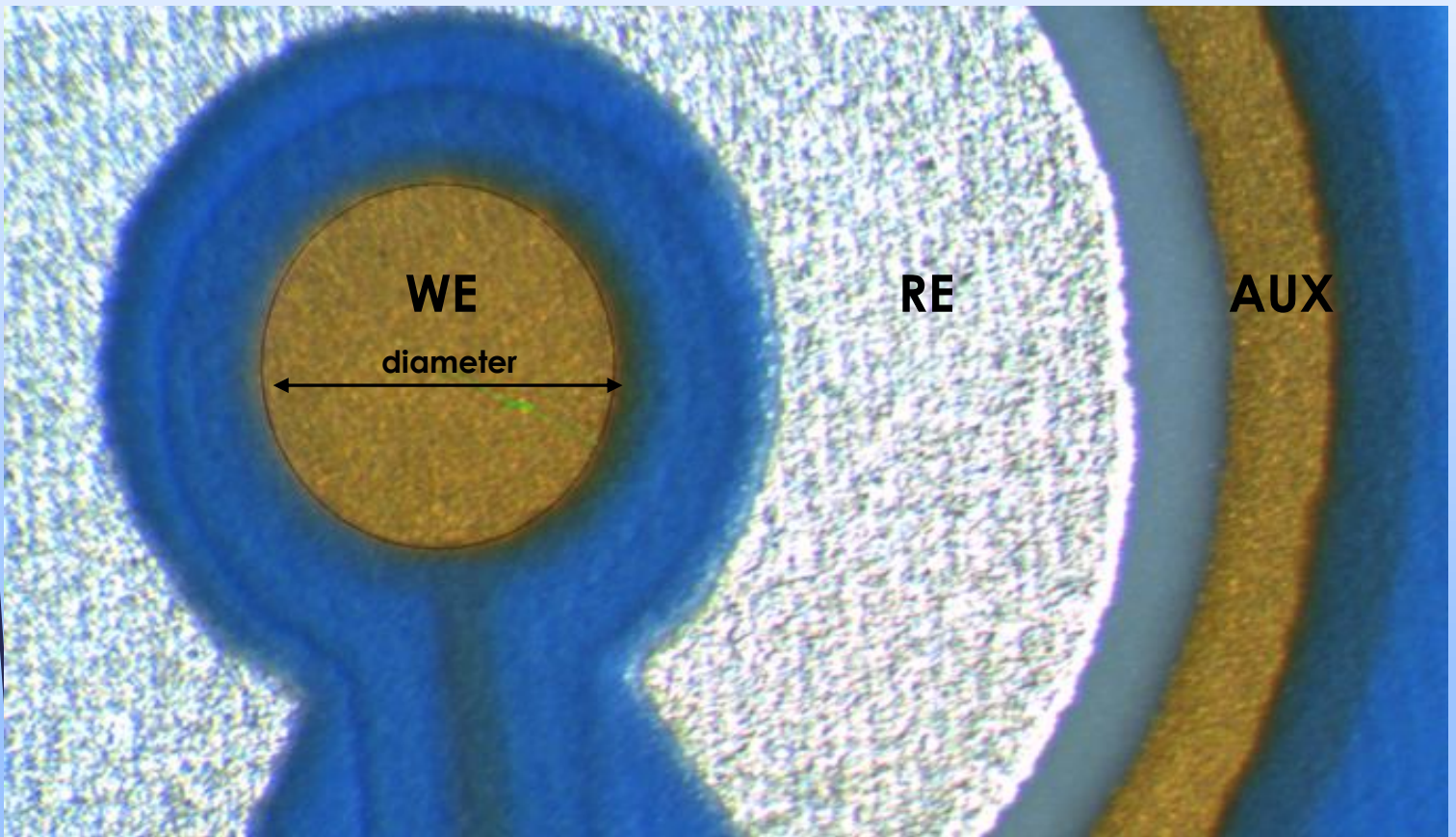

POLISHED SENSORS

We also offer a **working electrode made of polished materials AC1P.W*.R***, with homogenous surface with roughness less than 1 μm .

Comparison of **polished** (AC1P.W1.RS) sensors and unpolished (AC1.W1.RS) sensors

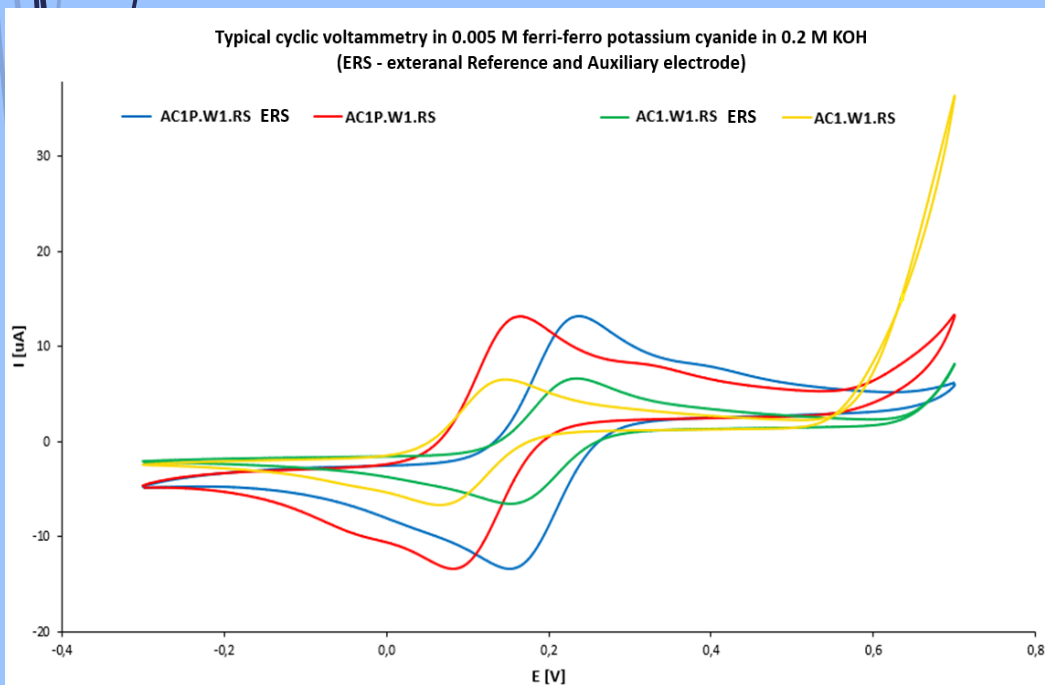

Measurement specification:

- Cyclic voltammetry, scan rate: 50 mV/s
- Temperature: 20 °C
- Working electrode: sensor AC1.W1.RS and polished sensor AC1P.W1.RS

Measurement with ERS

(external reference system - stable)

- 1.Reference electrode: RCEc.RS.R5 (external Ag/AgCl electrode (filled with 1M KCl))
- 2.Auxiliary electrode: external sensor AC4.W1

Measurement with sensor

- 1.The sensor's internal auxiliary and reference electrodes were used

Chemicals:

- KCl: 1M KCl
- FeFe: 0.005M $\text{K}_3[\text{Fe}(\text{CN})_6]$ + 0.005M $\text{K}_4[\text{Fe}(\text{CN})_6]$ in 0.2M KOH

W4 and W5 - GRAPHITE SENSORS

Active layer can be created by printing (W4) or microdispensing (W5).

AC1.W4. with screen printed graphite WE and AUX

The resulting printed layer has a working and auxiliary electrode made of graphite, the dielectric layer is made of polymer

- printed graphite working electrode has better properties in terms of surface reproducibility but has greater resistance between the electrode and the measuring device. Polymeric binder of active layer has limited resistance to organic solvents and sonification.



AC1.W5. with manually microdispensed graphite WE (Au+Pt alloy AUX)

The coated layer is made by microdispensing. It has only a working electrode made of graphite, the auxiliary electrode is made of another material (Au+Pt alloy), the dielectric is usually ceramic. Polymeric binder of active layer has limited resistance to organic solvents and sonification.

- manually applied working graphite electrode has better properties in terms of conductivity between the active surface and the input of the device, but it is not possible to ensure reproducibility of the surface in same level as in screen printing.

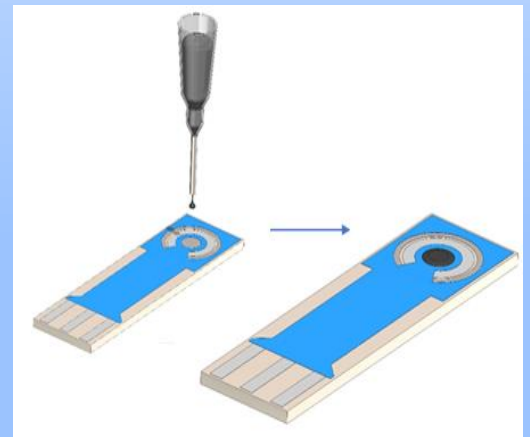

The active layer can be prepared from glassy carbon powder, carbon nanotubes and other carbon related materials.

BVT offers unactivated version of sensors. Both, W4 and W5 layers must be activated before measurements.

Graphite sensor activation example: AC1.W4.RS (2 mm WE)

Typical cyclic voltammetry in 0.005 M ferri-ferro potassium cyanide in 0.2 M KOH (ERS - external Reference and Auxiliary electrode)

— before activation
— after activation by 40 voltammetric cycles in 0,5 M KOH, potential range -1,5V to +1V

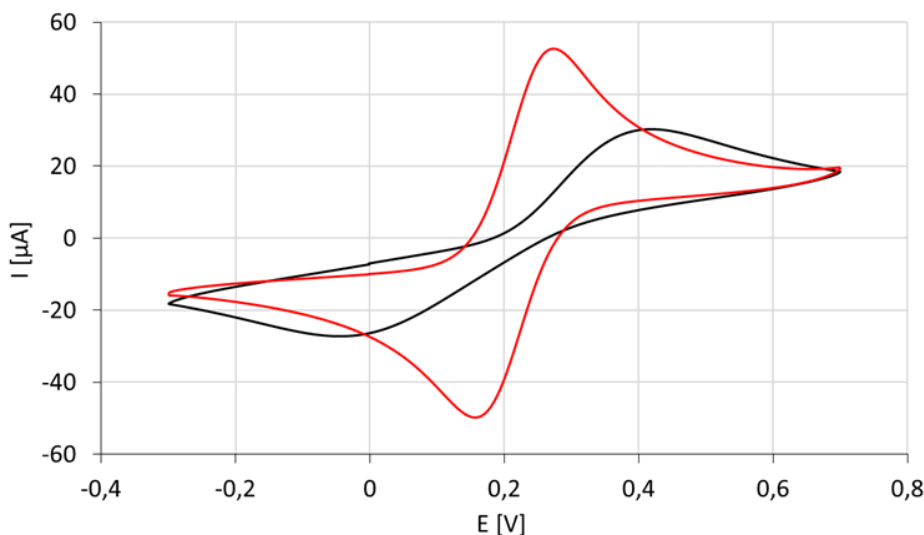

Measurement specification:

- Cyclic voltammetry, scan rate: 50 mV/s
- Temperature: 20 °C
- Working electrode: sensor AC1.W4.RS 2mm

All Measurements (activation of sensor working electrode and cyclic voltammetry) done with ERS

(external reference system - stable)

- 1.Reference electrode: RCEc.RS.R5 (external Ag/AgCl electrode (filled with 1M KCl))
- 2.Auxiliary electrode: sensor ACEc

Chemicals:

- KCl: 1M KCl
- FeFe: 0.005M $K_3[Fe(CN)_6]$ + 0.005M $K_4[Fe(CN)_6]$ in 0.2M KOH

BIOSENSORS

A bio-chemically active substance can be immobilised on the working electrode of the sensor to create a biosensor:

- **Glucose-oxidase (AC1.GOD) sensor**

Amperometric Glucose Oxidase three-electrode sensor with patented structure made by thick film technology
 Dimensions: 25.4 x 7.26 x 0.63 mm
 WE material: Pt

Glucose Oxidase (GOD) from *Aspergillus Niger* is immobilized on the active surface of a working electrode of amperometric substrate AC1.W2.RS. The diameter of the immobilized bioactive membrane is 2 mm and the mean applied activity is 1 unit/mm².

- **Acetylcholinesterase (AC1.AChE) sensor**

Amperometric Acetylcholinesterase three-electrode sensor with patented structure made by thick film technology
 Dimensions: 25.4 x 7.26 x 0.63 mm
 WE material: Pt

Acetylcholinesterase from electric eel type VI-S is immobilized on the active surface of a working electrode of electrochemical sensor AC1.W2.RS (i.e. Platinum working electrode, silver reference electrode). The diameter of the immobilized bioactive membrane is 2 mm and the mean applied activity is 1 unit/mm².

AC1.GOD. sensor in flow cell FC2

- sample supply to the sensor by diffusion injection analysis.

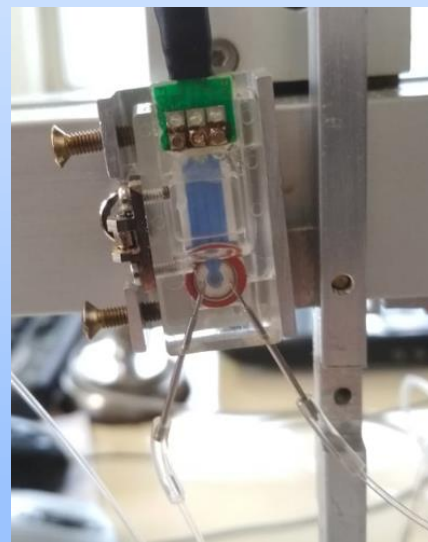

Electrochemical measurement of glucose using AC1.GOD sensor with immobilized glucose oxidase enzyme - example of a Calibration curve

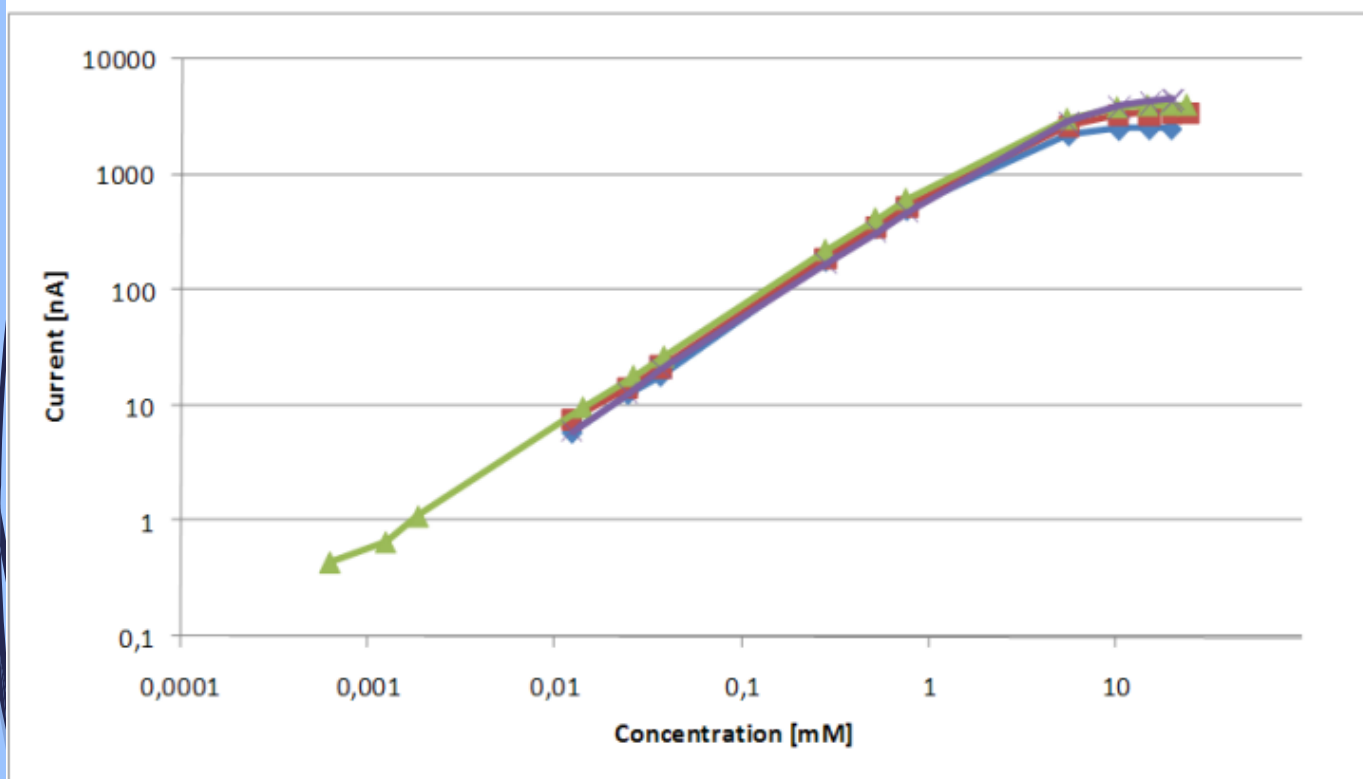

SENSORS chemical RESISTANCE

POLYMER VS CERAMIC DIELECTRIC PROTECTION LAYERS

Please note that each material has different mechanical and chemical resistance.

Polymer layers are cured at low temperatures and they have limited resistance to temperature and organic solvents. They are resistant against bases and acids.

On other way, **ceramic layers** are fired in temperatures more than 850°C. They have excellent resistance against temperature and organic solvents. They have lower resistance against acids and bases.

WORKING ELECTRODE MADE OF PURE METALS CAN HAVE LOWER ADHESION

WS - Au+Pt alloy:

The active layer is from Au+Pt alloy. Main advantage - good adhesion and chemical resistance.

W1 - Au:

The active layer is pure Au.

W2 - Pt:

The active layer is pure Pt. This layer can be destroyed by sonification, current over 10 mA and mechanical cleaning.

W3 - Ag:

The active layer is Ag

W4 and W5 - graphite:

The active layer is graphite (screen printed or microdispersed) in polymeric binder. Polymeric binder of active layer has limited resistance to organic solvents and sonification.

PLEASE NOTE THAT EACH MATERIAL OF RE HAS DIFFERENT MECHANICAL AND CHEMICAL PROPERTIES

RS - Ag:

Ag reference electrode with additives for better adhesion. Reference layer is partially covered by ceramic dielectric layer which is fired in temperatures more than 850°C. They have excellent resistance against temperature and organic solvents. They have lower resistance against acids and bases. The electrodes AC1.W*.RS can be heated up to 600°C (except of W4.RS and W5.RS).

R1 - 40% Ag + 60% AgCl (powder mixture in polymeric binder):

Ag/AgCl (40%:60%) reference electrode. Polymeric binder with limited resistance to organic solvents and sonification. Reference layer is covered by polymer dielectric layer which is cured at low temperatures. They have limited resistance to temperature and organic solvents. They are resistant against bases and acids. The electrodes AC1.W*.R1 can be heated to 150°C to about 2 hours until significant change of parameters. The longer curing will cause reference electrode degradation.

R2 - Ag covered by AgCl electrolytically:

Ag reference electrode covered by AgCl electrolytically. The color of this layer can be from light to dark brown. This layer degrades under the influence of light. **If your measurement is sensitive to silver contamination, prefer R1 or RS.** The electrodes AC1.W*.R2 can be heated up to 300°C (except of W4.R2 and W5.R2).

TEMPERATURE MEASUREMENT on sensors

All sensors of dimension 25.4 x 7.26 x 0.63 mm or 50.8 x 7.26 x 0.63 mm can be equipped with heating and temperature sensing element.

It enables the temperature measurement, its compensation or sensor heating and measurement at higher temperature.

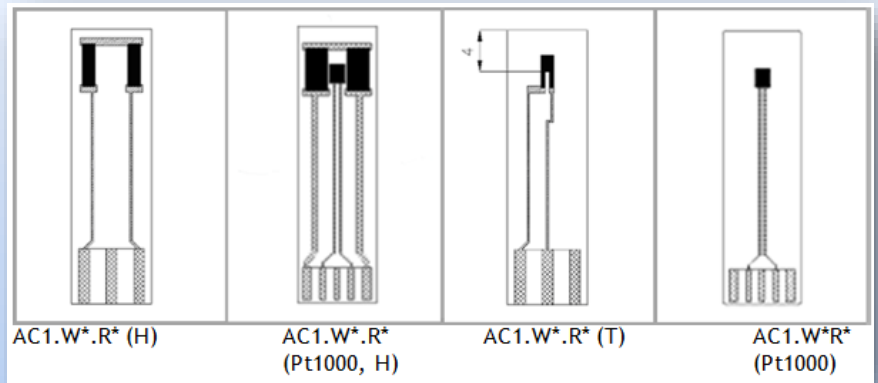

Reference

- G. U. Flechsig, O. Korbout, S. B. Hocevar, S. Thongngamdee, B. Ogorevc, P. Grundler, J. Wang, Electrically heated bismuth-film electrode for voltammetric stripping measurements of trace metals Electroanalysis 14 (2002) 192-196
- Jan Krejci, Zuzana Sajdlova, Jan Krejci, Jr. and Tomas Marvanek, Voltammetry under a Controlled Temperature Gradient, Sensors, 2010, 10, 6821-6835; doi:10.3390/s100706821

TEMPERATURE MEASUREMENT

Thermistor (cheap, high sensitivity, but must be calibrated)

Pt 1000 (response in agreement of ČSN EN ISO/IEC 17025, expensive)

Typical resistance of heating 50 Ohm
 Maximum usage temperature of usage
 Full ceramic technology 600°C
 Polymeric technology is used 150°C

The sensor with heating are typically equipped with connector with gold plated pins (needed for Pt 1000). The sensor can be used for application of thermo diffusion to control mass transport active electrode surface.

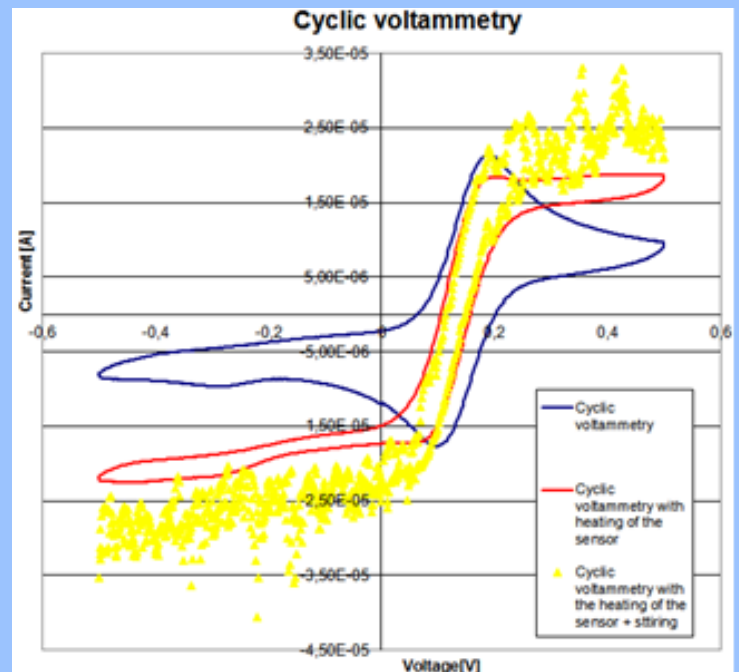
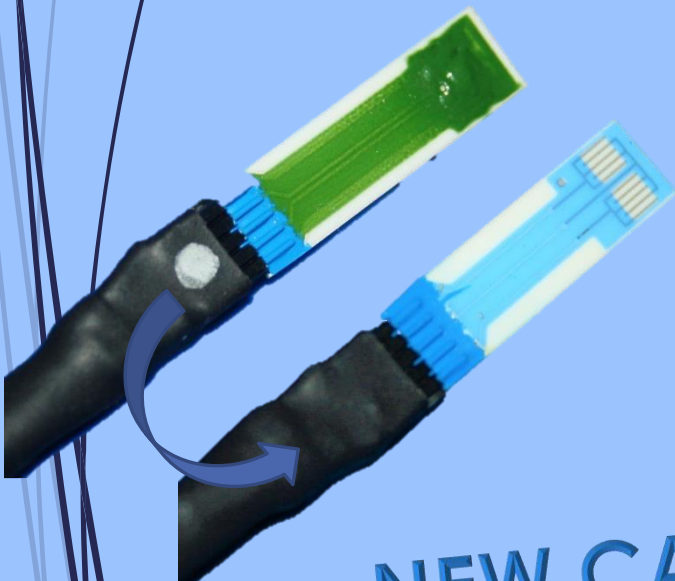
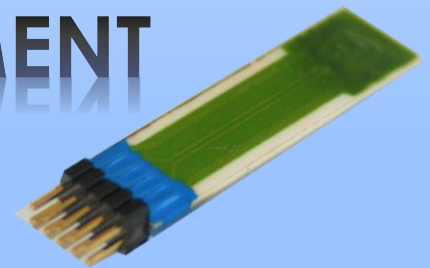

NEW CABLES FOR SENSORS
WITH Pt1000!

Innovation in electrodes

New series of classic electrodes with colour-coded casings are designed for measurements with glass cell TC4, TC5, TC6, TC9. Their standard connection is with a 2 mm banana cable.

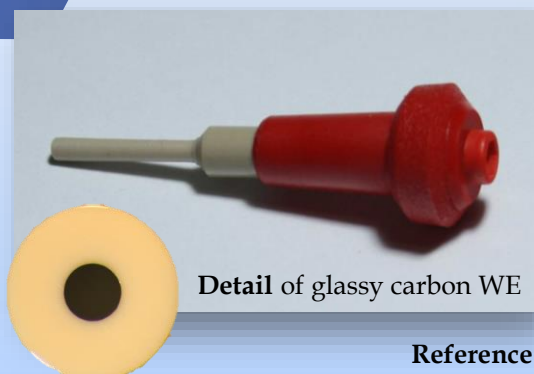

Detail of glassy carbon WE

Working electrode - WCEc

Materials:

Pt, Ag, Au - \varnothing 0,01mm - 3mm

Glassy carbon \varnothing 1mm 2 mm 3mm

Reference electrode - RCEc

Materials:

Ag/AgCl

Calomel electrode - CEc



Auxiliary electrode - ACEc

Materials: Pt

Length 8 mm

Diameter 0,5 mm



CONNECTORS AND CABLES ENDING

CABLE for BVT classic electrodes with different ending according to customers evaluating unit.

S - bare wires

1 - banana plugs 4 mm

2 - 7 poles BVT connector

3 - 3TRIAD, 3LEMO4, 3LEMO5

4 - BNC connectors

5 - banana plugs 2 mm

TRIAD



LEMO



4 pole



5 pole



2 - 7 poles BVT connector



5 - banana plugs 2 mm

See www.bvt.cz for more details.

OXYGEN CONCENTRATION MEASUREMENT WITH Universal potentiostat MPH471

The instrument enables measurement of amperometry, potentiometry and conductometry. Communication with the computer is provided via USB or Bluetooth. This hand-held device is equipped with GPS navigation so the measured data may be enhanced by the exact coordinates of the location where the measurement was made. Measured data can be stored and later processed in a PC because of the SD card slot incorporation. The ability to record a waveforms or integrate the measure values is enabled.

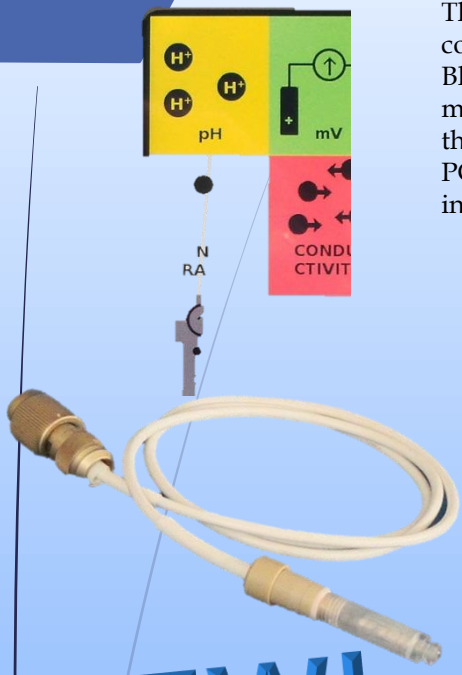

Responses to addition of Na_2SO_3 (sodium sulphite)

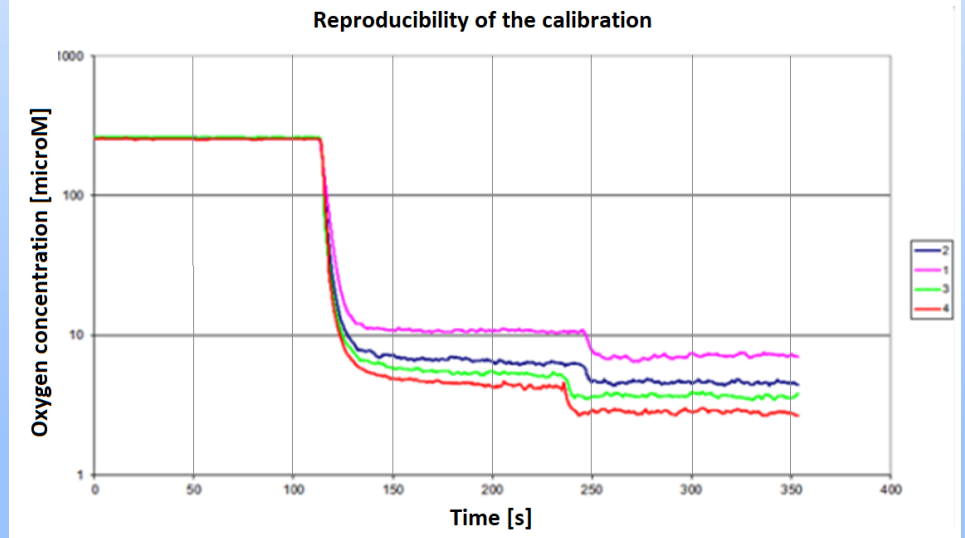

NEW!

Basic evaluation methods are also implemented – linear and non-linear calibration and standard addition method is available. The influence of the type of oxygen electrode membrane, temperature or gas solubility can be compensated for the measured values. The measured data are automatically recalculated and displayed in units of current, voltage, concentration ($\text{g}\cdot\text{l}^{-1}$ or $\text{mol}\cdot\text{l}^{-1}$) or saturation. Potentiometric measurement allows connection of pH electrodes and ISE.

Stability of oxygen sensor

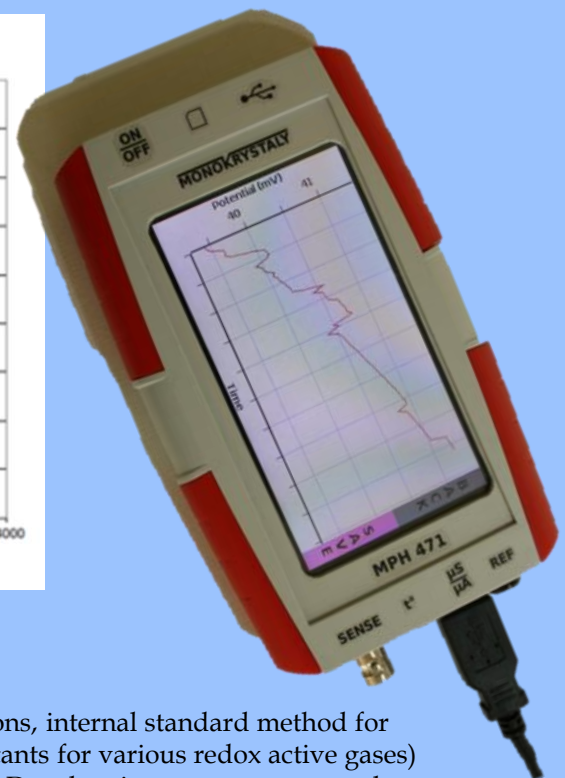
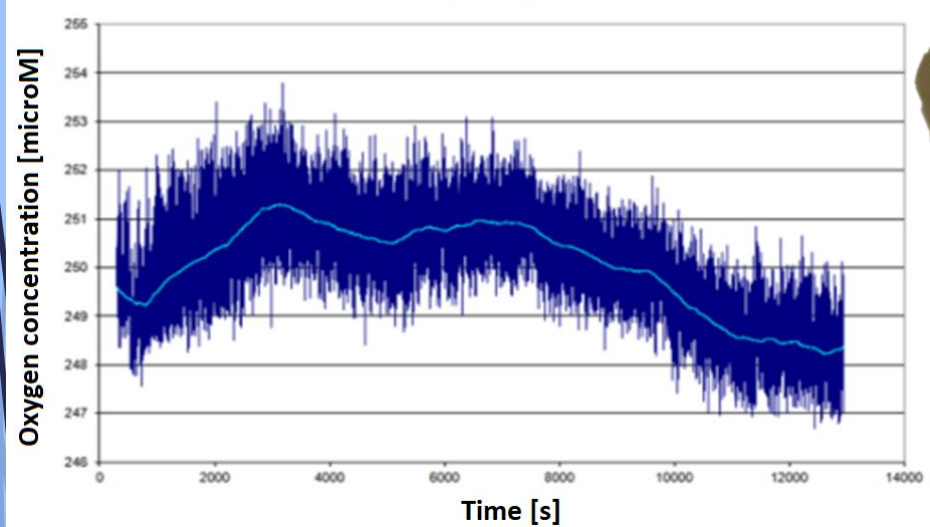

MAIN ADVANTAGES

- Battery life up to 200 hours
- Excellent tooling for analysts (graphs, unit conversions, internal standard method for potentiometry, coulometric titration, 10 Henry constants for various redox active gases) Power and data communication via USB, Bluetooth, Data logging on a memory card Up to 5-point calibration for ISE and pH electrodes, up to 4-point calibrations of the conductivity

Hanging platinum drop electrode (HPDE)

NEW!



Pt drop hanging electrode

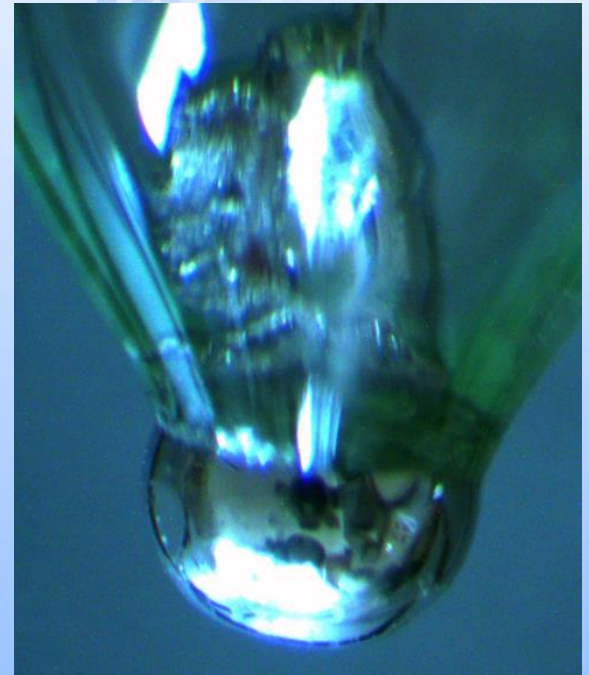

Pt drop hanging electrode - detail

Hanging platinum drop electrode (HPDE) is solid phase analogy of HMDE.

The drop of liquid Pt at 2000 °C forms a drop of Pt. The surface of HPDE has nearly ideal surface which is impossible to obtain using polishing. HPDE has also spherical symmetry which enables mathematical treatment of its response.

The material is not toxic and it is chemically stable. The only disadvantage is HPDE cleaning, which can be, however, in some cases solved by careful insertion of the electrode tip to the flame of alcohol burner.

Thus HPDE can be used as reference electrode for complicated electrochemical studies, where it is necessary to distinguish analytical signal from the signal generated by surface inhomogeneities.

Example of cyclic voltammetry measurement in Ferri-Ferro potassium cyanide in 0.2 M KOH

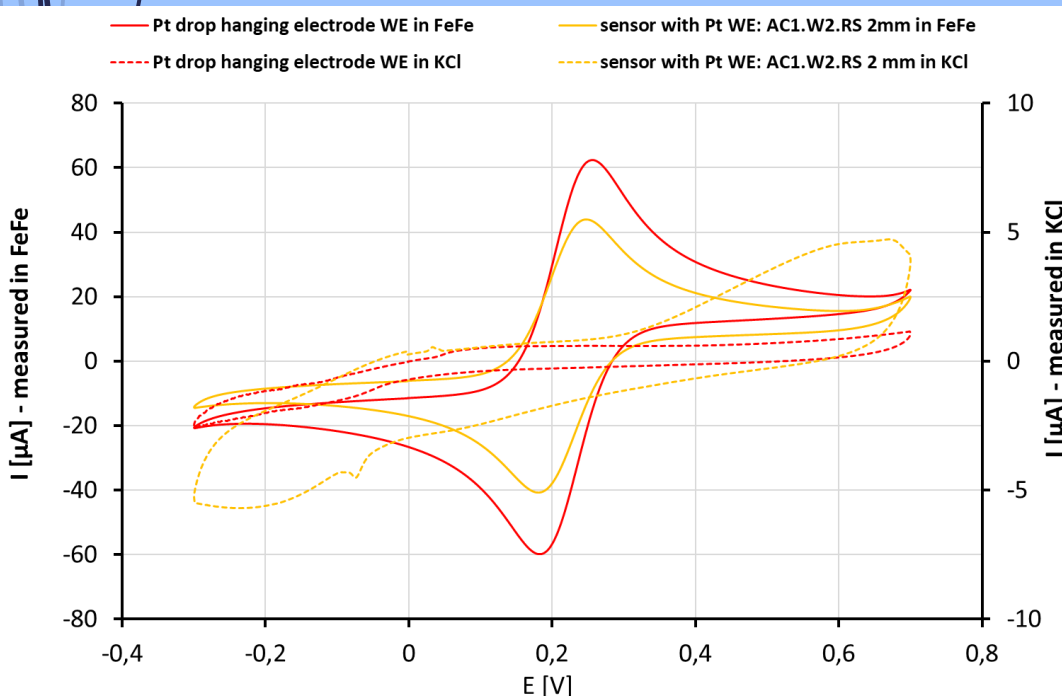

Measurement specification:

- Scan rate: 50 mV/s
- Temperature: 20 °C
- Working electrode: Pt drop hanging electrode
- Sensor with Pt WE AC1.W2.RS 2 mm

All measurements performed with ERS (external reference system - stable)

1. Reference electrode: RCEc.RS.R5 (external Ag/AgCl electrode (filled with 1M KCl))
2. Auxiliary electrode: external Pt wire electrode ACEc

Chemicals:

- KCl: 1M KCl
- FeFe: 0.005M $K_3[Fe(CN)_6]$ + 0.005M $K_4[Fe(CN)_6]$ in 0.2M KOH

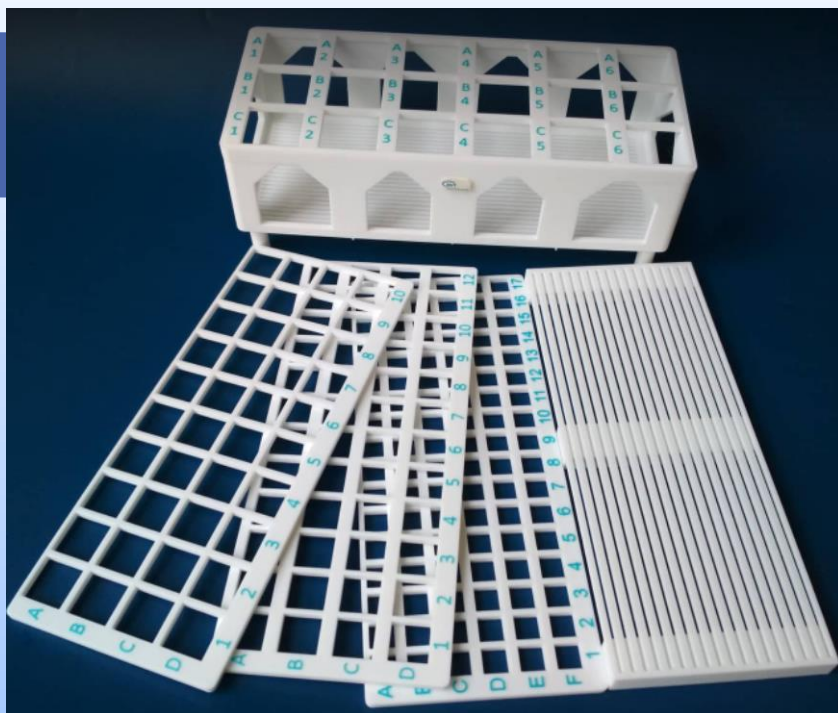

Description

BVT Custom Test Tube Stand for laboratory measurement needs.

The Stand's body is a solid structure with Interchangeable Lids. The Lids can be chosen with different Slot Sizes, for example a lid with holes of Diameter 20mm will have 40 Slots.

The amount of slots each lid has is dependent on the diameter of the holes.

Available Slot Diameters with corresponding Slot amounts:

- 11mm Diameter – 102 Slots
- 17mm Diameter – 48 Slots
- 20mm Diameter – 40 Slots
- 30mm Diameter – 18 Slots

Other Slot Diameters are available and can also be made to your required Diameters.

Physical Parameters

material PETG

Stand Parameters

Length: 245mm
Width: 105mm
Depth: 64.125mm
Height: 86.125mm

Internal Stand Parameters

Length: 236mm
Width: 96mm
Height: 12mm

The Stand and the Internal Stand are sold together.

Lid Parameters

Length: 241mm
Width: 101mm
Thickness: 4mm

This offers customers the ability to use the product even with shorter vials.

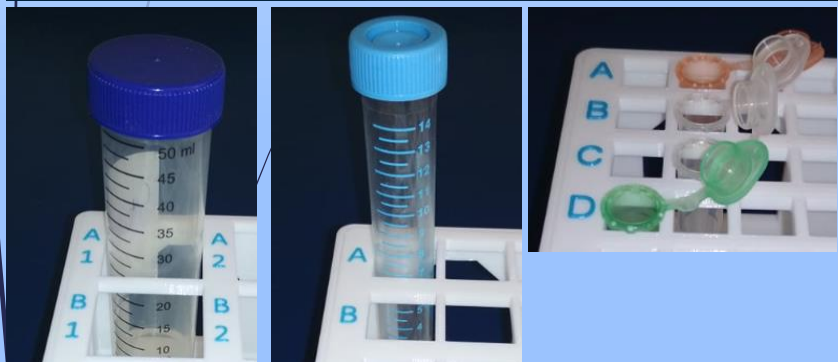

Description

Single-seat magnetic stirrer without heating used to stir liquids with a stirring bar. The mixing speed can be changed continuously using the rotary control: 0-255 rpm. Lightweight and easily portable, suitable for mixing liquids with a volume of up to 1 l. The magnetic stirrer includes a connector connected to a 12 V power supply.

Physical Parameters

material PETG

Length: 159mm
Width: 137mm
Height: 60mm
Weight: 272 g

The single-seat magnetic stirrer includes two glass magnetic stirring bars.



NEW!



LABORATORY ACCESSORIES

Description

Pipette stand with a round base, designed for storing a large number of glass pipettes. Made to be robust and long-lasting, for easy organization, storage and use. The round stand contains 35 holes with a diameter of 11.38 mm and 14 holes with a diameter of 7.89 mm.



Physical Parameters

material PETG

Height: 305 mm

Diameter of the upper circular base: 150 mm

Diameter of the lower circular base: 170 mm

The lower round base of the stand can be separated from the stand for easy washing.

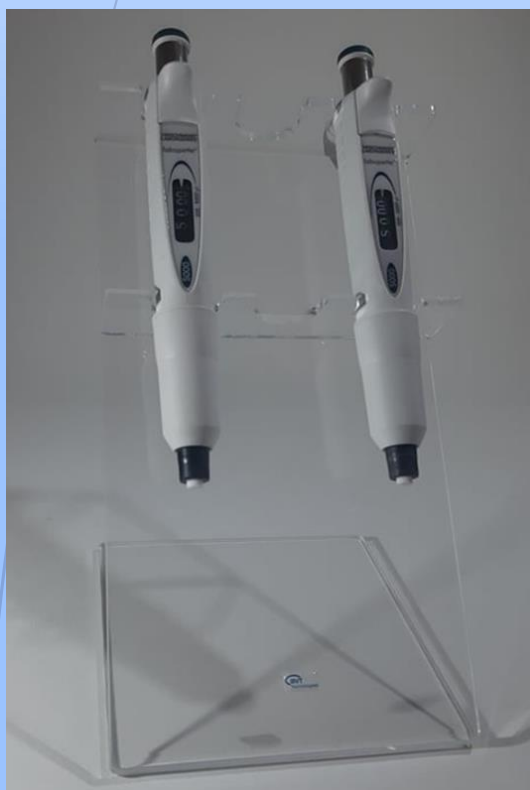

Description

BVT Automatic Pipette Stand, designed to hold 3 Pipettes, for ease of organization, and clearing lab clutter.

Designed to be robust and long lasting.

Physical Parameters

Length: 175mm

Width: 160mm

Height: 250mm

NEW!



Description

Petri Dish Stand. The individual stands fit together and can be stored vertically on top of each other.

The dimensions of the stand are designed for a petri dish with a diameter of 90 mm

It is possible to make the stand in other dimensions according to the size of the customer's petri dishes.

Physical Parameters

material PETG

Stand Parameters

Outer diameter: 106 mm

Inner diameter: 95 mm

Height: 27.14 mm



EASY WASHABLE GLASS CELL TC6 with stoppers

Hand made glass cells for electrochemical measurements which enable measurements with miniaturised BVT classical electrodes. The cells have a lid with NJ openings (NJ 10/8, NJ 12/10) - to fix electrodes, stirrer or connector in the cell. Stoppers are used for **prevention** of solution **evaporation**, for **bubbling**, for **dosing** by tubes or for measurements in an inert atmosphere.

Types of glass cells:

TC4 - conic openings, thermostated by MT1

TC5 - conic openings, thermostated by external thermostat

TC6 - conic openings, **easily washable**

TC9 - with folder for electrochemical sensor AC9C

Stand for TC6

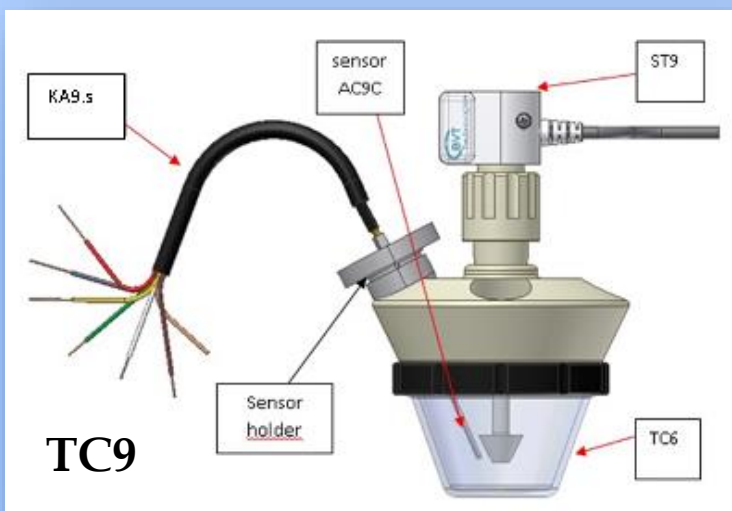
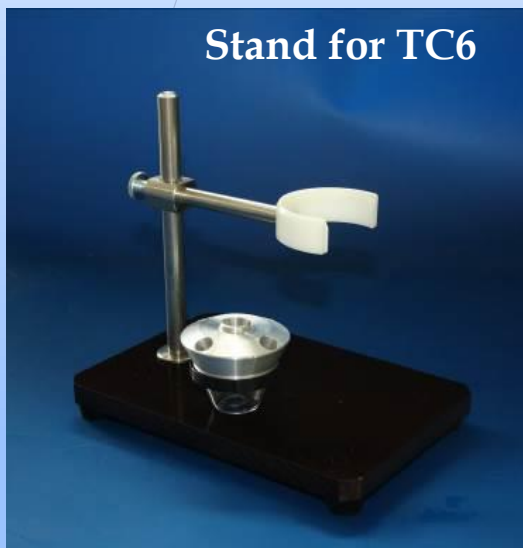

It contains:

- 7 positions for electrochemical vessels
- Control box for connection of stirrer, electrodes, stimulation signals and gass handling (electromagnetic switches)

Main advantage

no movement of cables and electrodes when the cells are interchanged

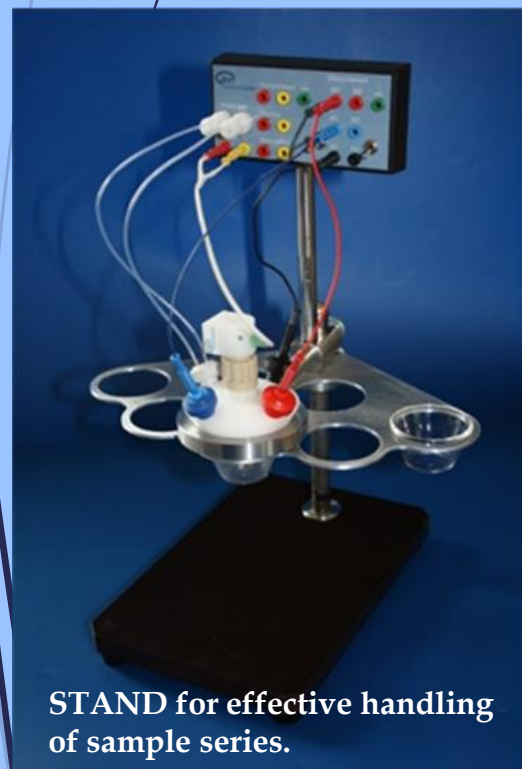

STAND for effective handling of sample series.

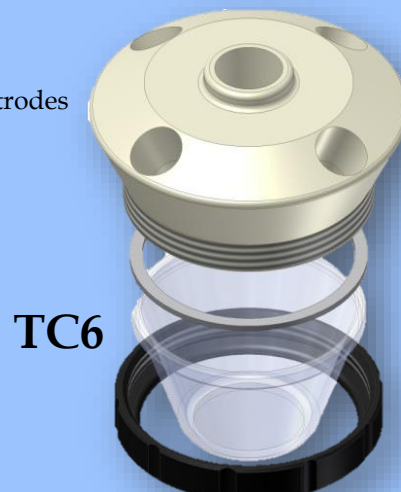

LOW COST DUAL CHANNEL PERISTALTIC PUMP 2PP.T

The peristaltic pump 2PP.T* is simple device for routine laboratory use. The pump has two channels. The flow is in one direction. The lifetime of tubing is optimized to maximal value. The pulsation is minimized for flow cell FC2.

The pump is supplied by max 12V. The rotation speed is controlled by voltage. The control unit can be delivered with pump. The force on the tubing is adjusted by screw and spring. The pulsation damper can be ordered separately.

- The pump is provided with 2 spare tubing. Required diameter should be specified by customer: 0.25 mm, 0.51 mm, 0.76 mm, 1.02 mm, 2.54 mm or 3.17 mm.

Model	Dimensions			
	Length	Height	Width	Weight
2PP	115 mm	84 mm	74 mm	340 gms

Technical Parameters	2PP.TS
Double channel	•
4 rollers	•
Voltage: 3V-12V	•
Consumption: 150 mA - 220 mA - 600 mA (min - typical - max)	•
Starting current: 1000 mA (10 ms)	•
Flow in range: 10 - 15000µl/min	•



The integrated shaft enables fastening by standard laboratory clamps.

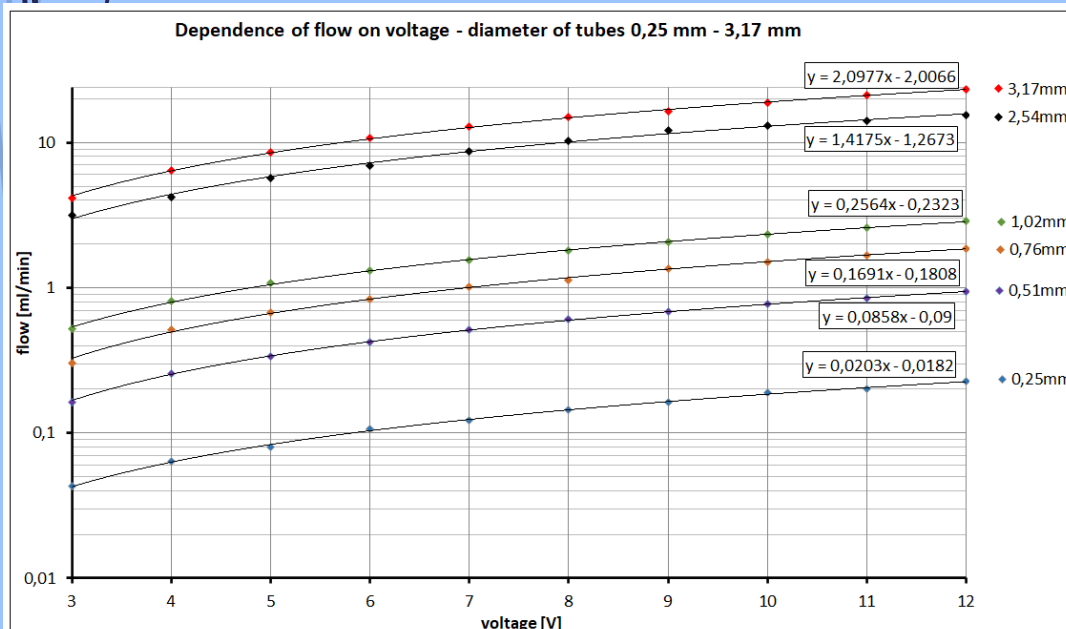
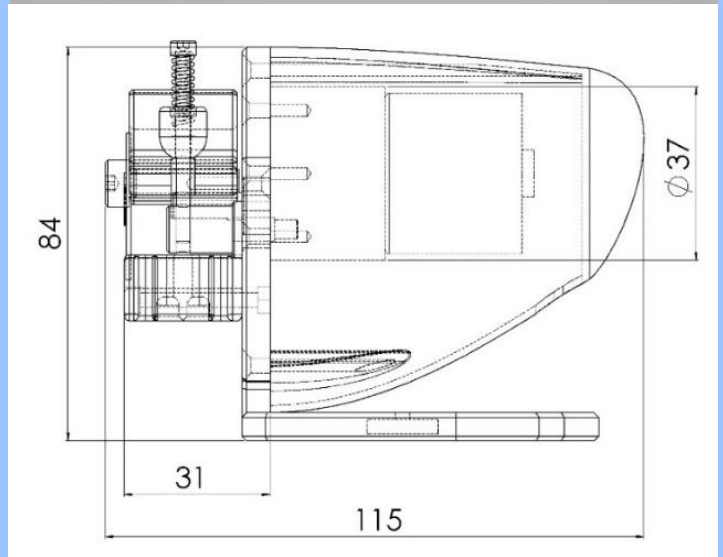

- Calibration curve
- Long term stability
- Pulsation damper can be added
- The pump is provided with 2 spare tubing.
- Required diameter should be specified by customer: 0.25 mm, 0.51 mm, 0.76 mm, 1.02 mm, 2.54 mm or 3.17 mm.

NEW!

Mini RDE

ST1 Simple motor

NJ 12/10, fits of TC4, TC5, TC6 glass cell,
 revolutions range: 120 - 12000 rpm
 BVT pwm control
 Simple and low cost solution

ST3 Precision Maxon motor with gearbox and encoder

optimum mass transport
 minimum hydrodynamic noise
 consists of TC4, TC5, TC6 glass cell,
 control electronics and SW
 can be used as USB device
 revolutions range: 10 - 1300 rpm
 the revolutions are programable



ST1 BVT pwm control unit

The universal BVT control for stirrer ST1.
 The input voltage 5 V and 0,5A
 Connector/USB enable to use it as USB device
 (PC, Power bank, Mobile charger).
 The output voltage 0-5V 2mm banana plugs

ST3 CONTROL RPM

Motor driver v 4.0 - USB Device Connected - CMD OK

Manual control | Program control

Current program step: **14** Start from the beginning Start from selected line

Time to next step [s]: **0** End of program **Program stopped**

Reported speed: **438 rpm**

Program table:

Line Nr	Time [s] / step	Speed [rpm]
1	30	50
2	30	60
3	30	70
4	30	80
5	30	90
6	30	100
7	30	110
8	30	120
9		
10		
11		
12		
13		
14		

Load from csv Save to csv Copy to clipboard

Delete row Add row before Add row after

Communication idle

Motor driver v 4.0 - USB Device Connected - CMD OK

Manual control | Program control

FW version info: **v 4.0**

Reported speed: **438 rpm**

Speed: **440 rpm** (Selected: 603 rpm)

Motor control: **START** **STOP** Select direction: direction A direction B

■ Manual control

■ Program control

Potentiostat GX102 and screen printed sensors BVT

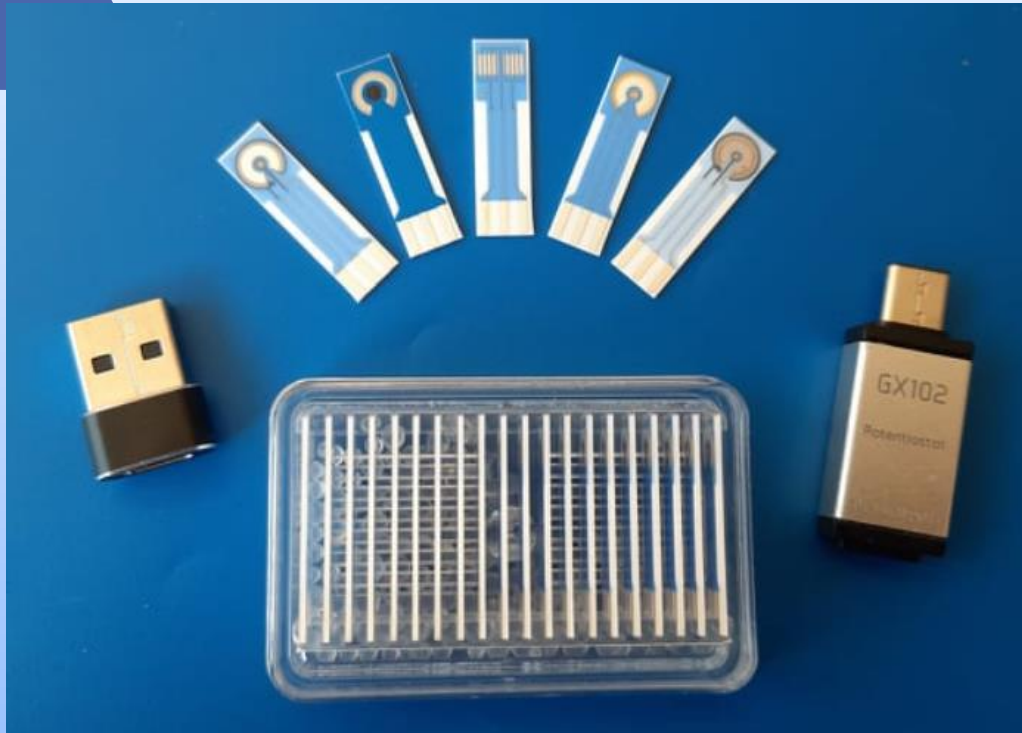

NEW!

solarbiotec

Example of cyclic voltammetry arrangement on a pair of potassium ferro-ferro cyanide with KOH:
potentiostat GX 102 - SOLAR BIOTEC, sensors AC1.W*.R* - BVT, glass electrochemical cells TC6 with stand - BVT

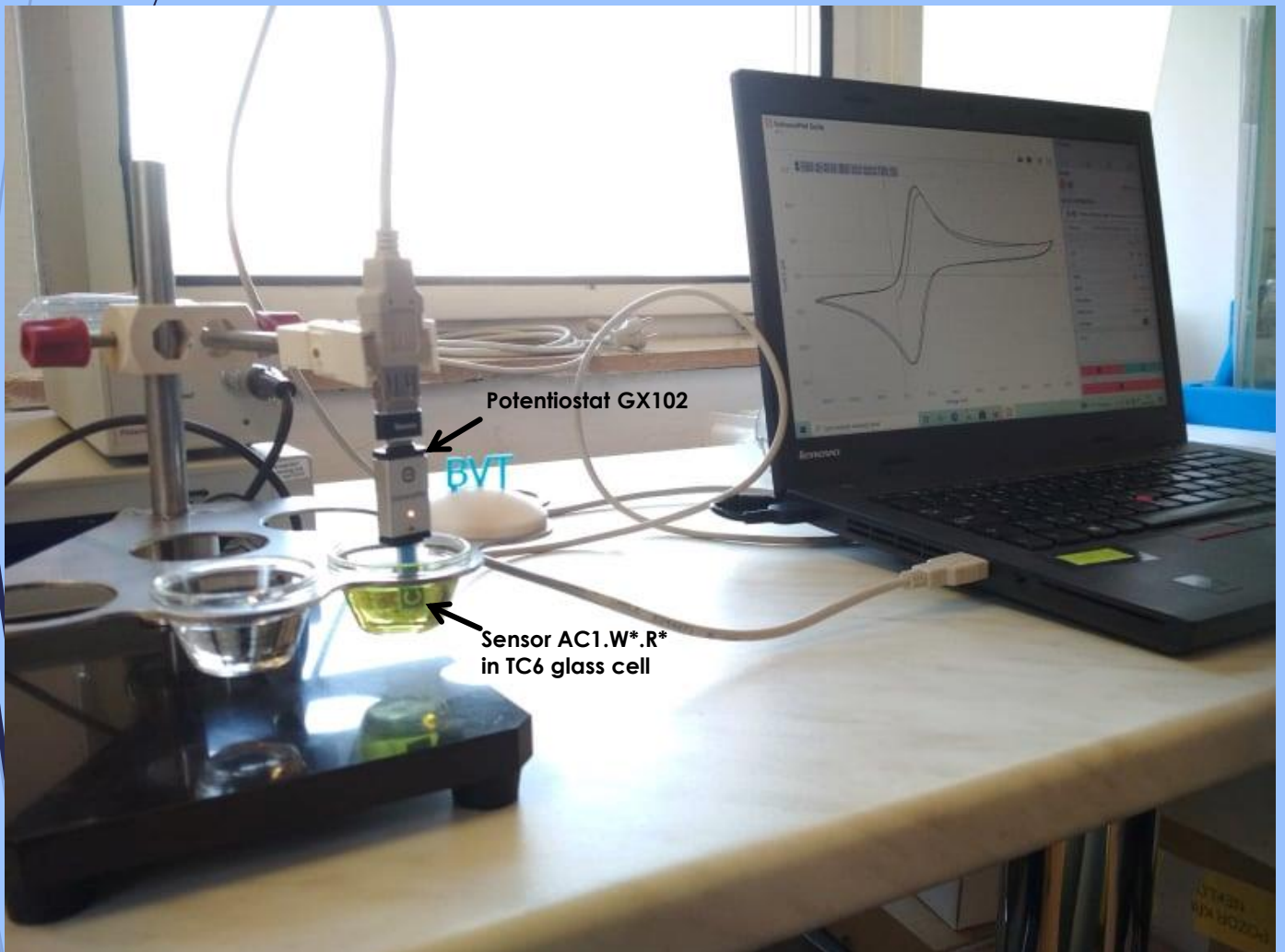

DISTRIBUTION PALMSENS 2022

PALMSENS4



Description

Our flagship instrument, the PalmSens4, is a USB and battery powered Potentiostat, Galvanostat, and optional a Frequency Response Analyser (FRA) for Electrochemical Impedance Spectroscopy (EIS). The PalmSens4 has a large potential range (-5V to 5V or -10V to 10V) and current range (100 pA to 10 mA) with a high resolution and low noise.

The economical PalmSens4 is a complete laboratory instrument but its compact and rugged design makes it also ideal for field work. Connecting via Bluetooth guarantees a perfectly floating measurement.

Configurable

PalmSens4 comes in different configurations:

±5 V or ±10 V potential range

EIS/FRA with maximum frequency of 100 kHz or 1 MHz

optional Bipotentiostat module for second WE

optional iR-Compensation

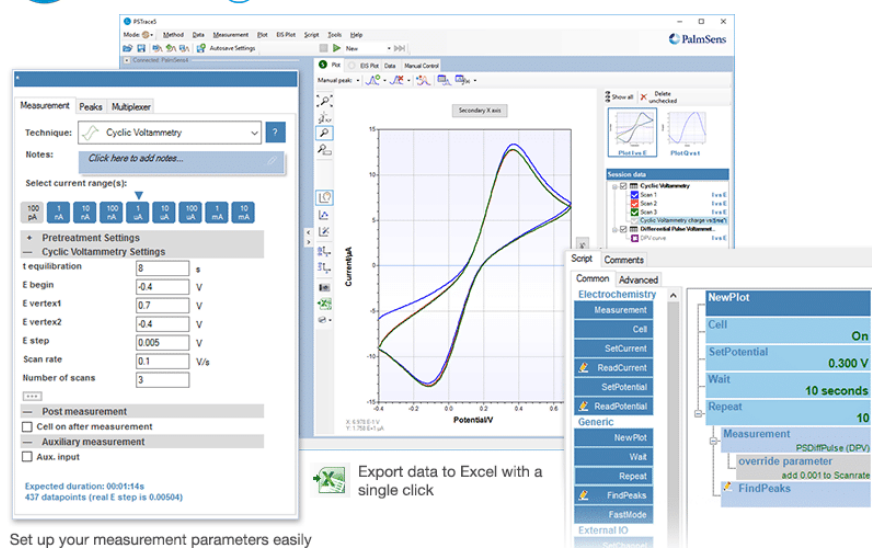

Set up your measurement parameters easily

Scripting for running a set of automated tasks

On Thursday April 9, 2020, Chris Cassidy and two Russian astronauts were launched into space with a Soyuz MS-16 rocket at Site 31 at the Baikonur Cosmodrome in Kazakhstan being part of NASA [expedition 63](#). Part of their payload: a [PalmSens4 potentiostat](#).



MICROELECTRODES

Description

Microelectrodes consist of small diameter metal wires or fibers (5-100 μm) sealed within tempered glass bodies. The flattened end of the microelectrode is polished to a mirror finish, which can be maintained using the polishing materials contained in the PK-4 Polishing Kit. The electrical connection is a 0.060" gold-plated pin. Dimensions of the electrode are approximately 7 cm long and 4 mm OD. Each microelectrode is visually inspected and electrochemically tested before shipping.

Ordering Information

Platinum

Part Number	Description
MF-2005	10 μm diameter Platinum Microelectrode
MF-2151	25 μm diameter Platinum Microelectrode
MF-2152	50 μm diameter Platinum Microelectrode
MF-2150	100 μm diameter Platinum Microelectrode

Gold

Part Number	Description
MF-2006	10 μm diameter Gold Microelectrode
MF-2153	25 μm diameter Gold Microelectrode
MF-2154	50 μm diameter Gold Microelectrode
MF-2155	100 μm diameter Gold Microelectrode

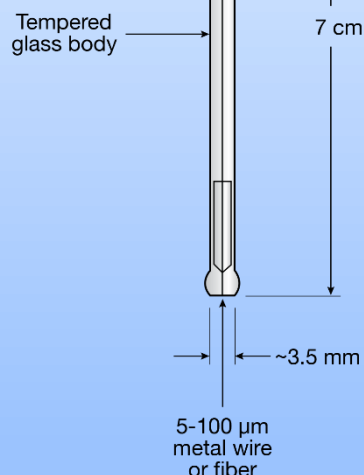

Carbon Fiber

Part Number	Description
MF-2007	11 μm ($\pm 2 \mu\text{m}$) diameter Carbon Fiber Microelectrode

Custom fabrication is available, e.g. 25 μm silver, 25 μm gold, etc. Please Contact BASi to discuss your requirements



BVT Technologies was granted projects for:

New generation of ISE electrodes : CZ.01.1.02/0.0/0.0/21_374/0027289

The aim of the project is to introduce new ion-selective electrodes suitable for continuous measurement. The result of the project will be

- ISE prototypes with a diameter of 6 mm for the determination of Cl, Na, K, Ca ions
- Prototypes of flow chambers for 3 analytes and reference electrode and flow chambers for 1 analyte and reference electrode with integrated stirrer
- Report analyzing the possibility of further miniaturization of ISE electrodes (< 3 mm) and verification of the possibility of determining other analytes - new ionophores.

The project will be co-financed from financial resources obtained through the sale of electrochemical sensors and biosensors.

The co-beneficiary will finance the project from the sale of classic ISE electrodes and their accessories.

The prototypes will be followed by production.

The new ISE and flow chambers will enable the use of ISE electrodes for continuous measurement and their integration into automatic control systems.

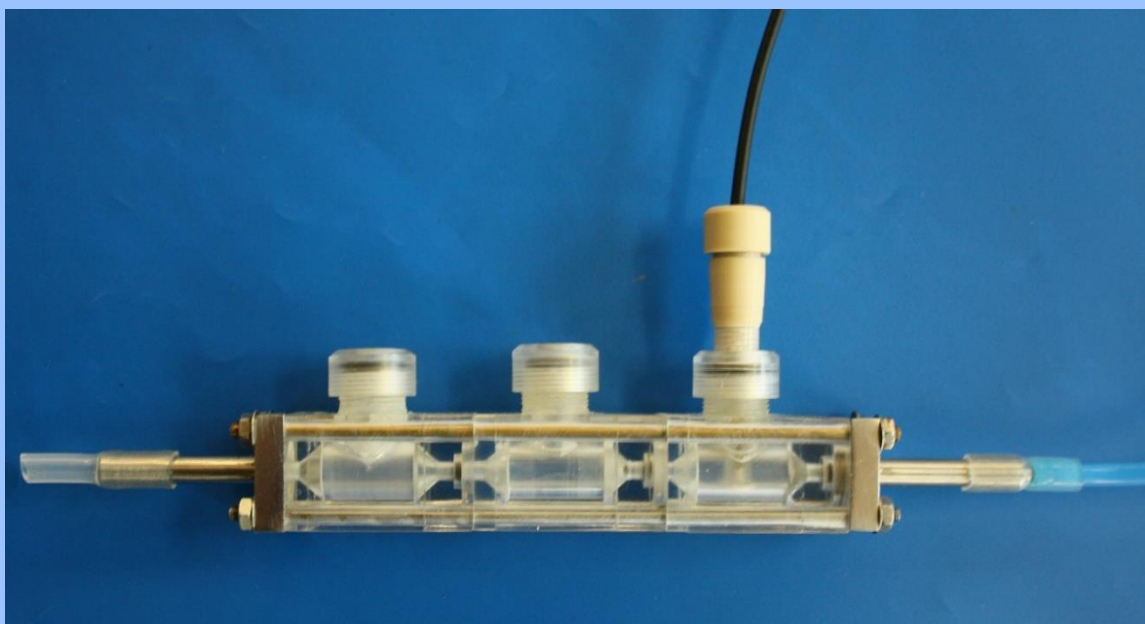

CUSTOMER'S PROJECTS SUPPORT

TRAINING – usage of sensors,
training of work with our instruments and apparatus



- ✓ Glucose sensors, their use and measurement
- ✓ AChE sensors, their use and measurement
- ✓ Activity of enzymes measurement
- ✓ Inhibition of enzymes measurement
- ✓ Detection of organophosphorus and carbamate pesticides
- ✓ Biosensors based on interaction between algae and analyte
- ✓ Detection of herbicides
- ✓ Measurement of bioavailable toxic compounds
- ✓ The application of biosensor on demand of customer (If necessary the cost of preparation and special sensors or chemicals is added to the standard price.)



ORGANIZATION of workshops, project meetings

The training activities can be connected with workshop or summer school with interesting social program.



NEW ARTICLE

Review | [Published: 14 January 2022](#)

Microdialysis techniques and microdialysis-based patient-near diagnostics

[Mark Thomas O'Connell](#)  & [Jan Krejci](#)

Analytical and Bioanalytical Chemistry **414**, 3165–3175 (2022) | [Cite this article](#)

206 Accesses | **1** Citations | **2** Altmetric | [Metrics](#)

Abstract

This article will debate the usefulness of POCT measurements and the contribution microdialysis can make to generating valuable information. A particular theme will be the rarely considered difference between ex vivo sampling, which typically generates only a static measure of concentration, and in vivo measurements that are subject to dynamic changes due to mass transfer. Those dynamic changes provide information about the patients' physiological state.

O'CONNELL, Mark Thomas a Jan KREJCI. Microdialysis techniques and microdialysis-based patient-near diagnostics. *Analytical and Bioanalytical Chemistry* [online]. 2022, **414**(10), 3165-3175. ISSN 1618-2642. Dostupné z: [doi:10.1007/s00216-021-03830-6](https://doi.org/10.1007/s00216-021-03830-6)

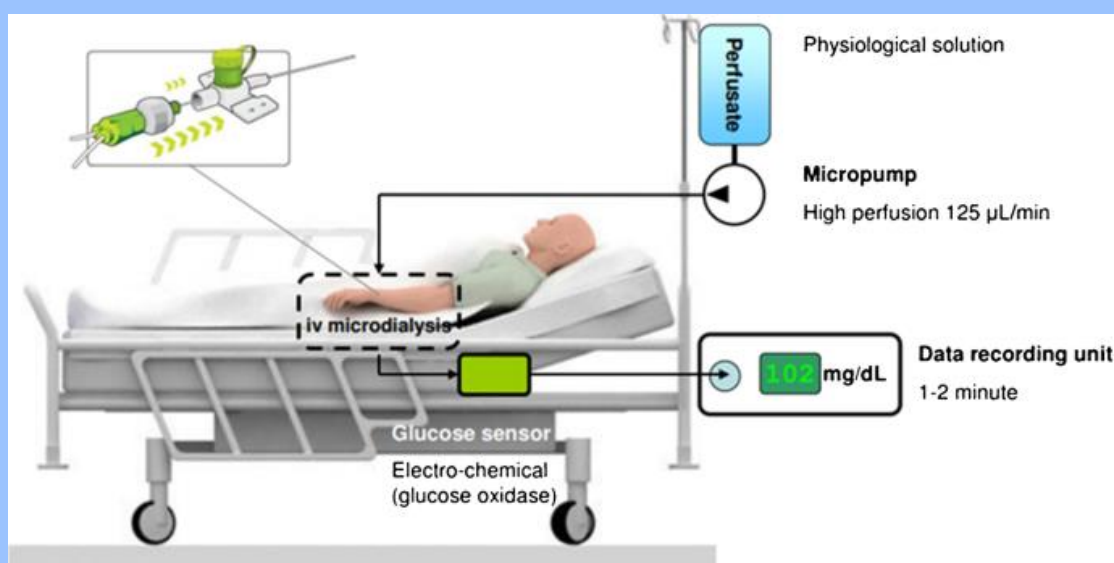

<https://link.springer.com/article/10.1007/s00216-021-03830-6>



BVT Technologies
BVT Technologies, a.s.
Strážek 206, Strážek 592 53
www.bvt.cz, info@bvt.cz

NEW BVT ARTICLE

Perspective—Thick Film Technology

Radka Kucerova¹, Lucie Jezova¹ , Stepanka Bendova¹, Anna Belusova¹ , Yuvraj Bhardwaj¹  and Jan Krejci¹

Published 28 February 2022 • © 2022 The Electrochemical Society ("ECS"). Published on behalf of ECS by IOP Publishing Limited

[Journal of The Electrochemical Society, Volume 169, Number 2](#)

[Focus Issue on Women in Electrochemistry](#)

Citation Radka Kucerova *et al* 2022 *J. Electrochem. Soc.* **169** 027519

Abstract

Thick Film Technology (TFT) offers a new platform for analytical procedures in Electrochemistry. The most routine technology is screen printing. However, it can introduce new procedures connected with miniaturisation or combination of microfluidic and electrodes. TFT use in electrochemistry is discussed. Examples of different sensors are demonstrated. Details are referred to in the original literature. Advanced applications combining TFT with other technologies are demonstrated (capillary electrophoresis on a chip and a sensor with integrated heating and thermometer). Future of TFT in electrochemistry is discussed, also the drawbacks, connection to production and commercial application are noticed.

KUCEROVA, Radka, Lucie JEZOVA, Stepanka BENDOVA, Anna BELUSOVA, Yuvraj BHARDWAJ a Jan KREJCI. Perspective—Thick Film Technology. *Journal of The Electrochemical Society* [online]. 2022, **169**(2). ISSN 0013-4651. Dostupné z: doi:10.1149/1945-7111/ac5546

https://www.researchgate.net/publication/358630407_Perspective-Thick_Film_Technology



BVT Technologies
BVT Technologies, a.s.
Strážek 206, Strážek 592 53
www.bvt.cz, info@bvt.cz

Do not hesitate to visit our website www.bvt.cz for more information !



Home ▾ BVT Team Contact and Location International Partners, Affiliates and Distributors Downloads and Links ▾ Services How to order

- Category
- Sensors
- Electrodes
- Stirres
- Cables and connectors
- Cell
- Potentiostats
- Manual Screen Printer
- Minithermostat
- Pumps
- Accessories

Home

Home

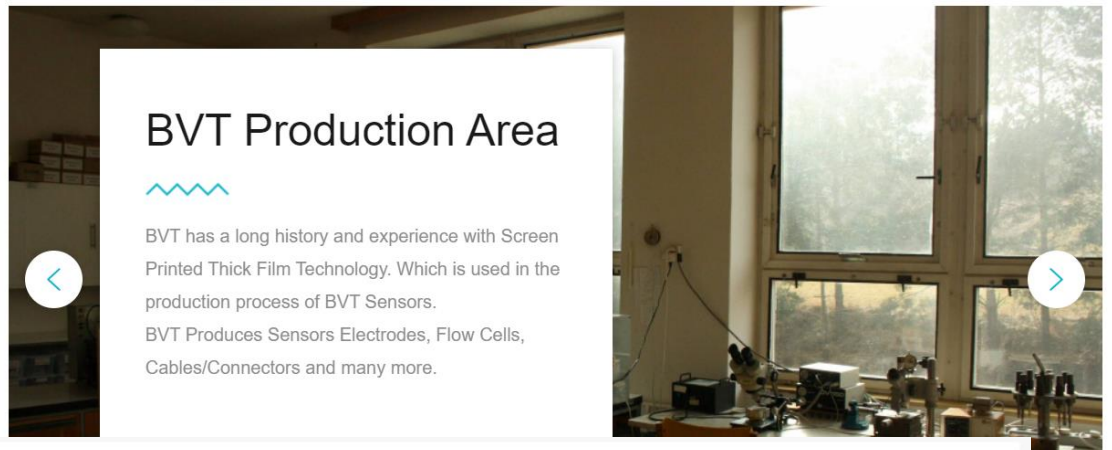

BVT Production Area

BVT has a long history and experience with Screen Printed Thick Film Technology. Which is used in the production process of BVT Sensors.
BVT Produces Sensors Electrodes, Flow Cells, Cables/Connectors and many more.

BVT has a number of Partners, Affiliates and Distributors in different parts of the world, which can be seen below.

If you would like to visit their websites, please click on the logos.

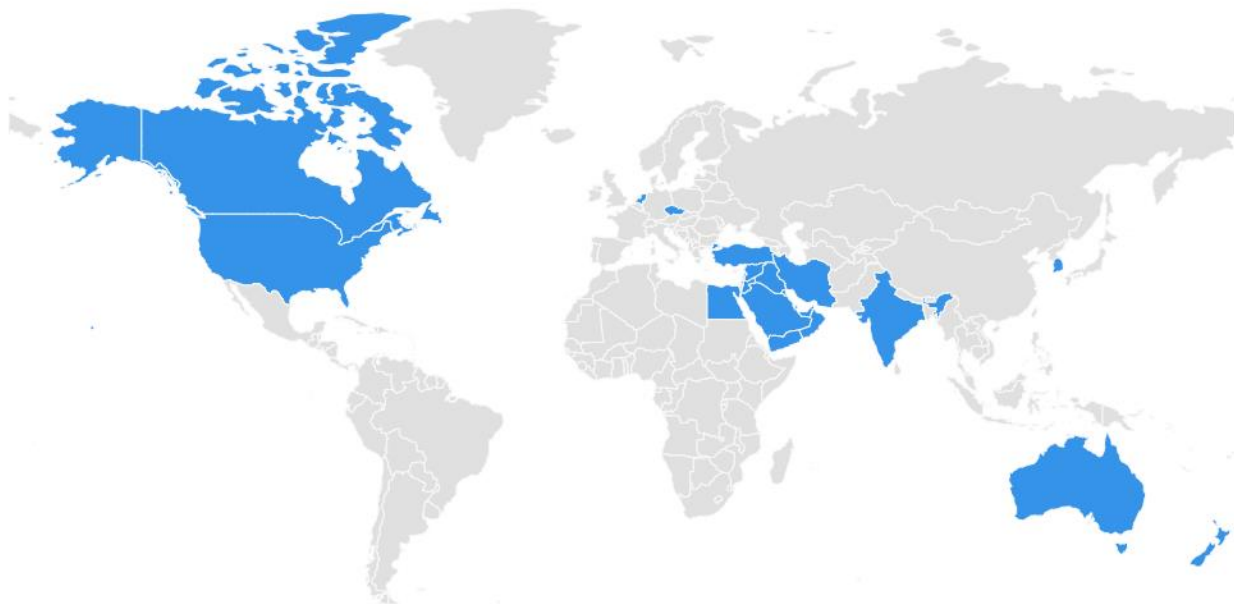

If you would like to create a partnership/affiliation/distributorship between yourselves and BVT please do not hesitate to reach out to us through our 'Contact and Location' Page.

www.bvt.cz, info@bvt.cz